

ARCHITECTURAL UNITS:

3-U Fluted Split Face

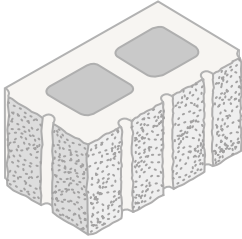

**8 x 8 x 16 3U
Fluted Split 1 Face****

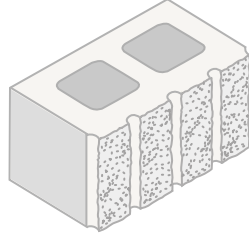

**8 x 8 x 16 3U Fluted
Split 1 Face / 1 End****

3-V Fluted Split Face

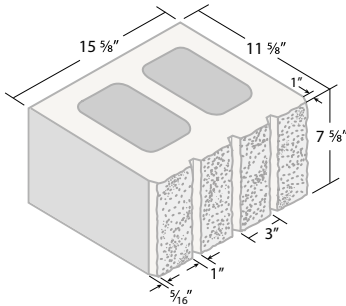

**12 x 8 x 16 3V
Fluted Split 1 Face****

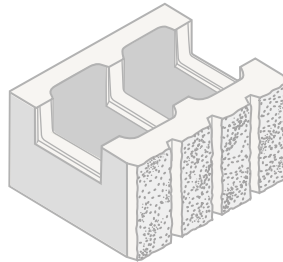

**12 x 8 x 16 3V Fluted Split
Bond Beam, 1 Face****

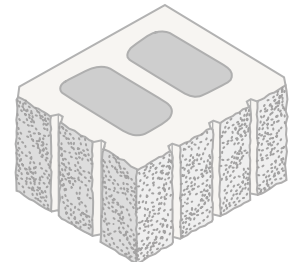

**12 x 8 x 16 3V Fluted Split
1 Face / 1 End****

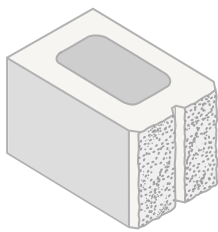

**12 x 8 x 8 3V Fluted
Split 1 Face Half****

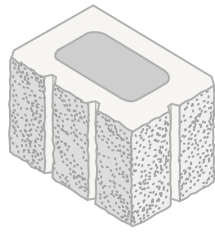

**12 x 8 x 8 3V Fluted
Split 1 Face / 1 End Half****

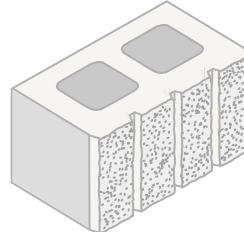

**8 x 8 x 16 3V Fluted
Split, 1 Face***

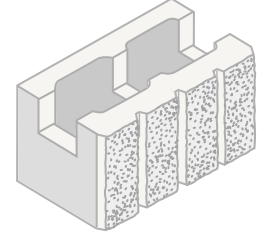

**8 x 8 x 16 3V Fluted Split
Bond Beam, 1 Face***

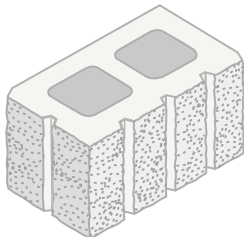

**8 x 8 x 16 3V Fluted Split
1 Face / 1 End***

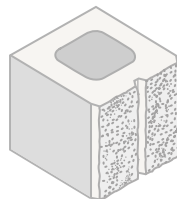

**8 x 8 x 8 3V Fluted Split
1 Face Half****

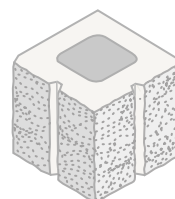

**8 x 8 x 8 3V Fluted Split
1 Face / 1 End Half****